



B12V100AF

CONSTRUCTION

Nominal Voltage	12V	
Nominal Capacity(10HR)	100.0AH	
Dimensions	Length	330±3mm (12.99 inches)
	Width	173±2mm (6.81 inches)
	Container Height	212±3mm (8.35 inches)
	Total Height (with Terminal)	220±3mm (8.66 inches)
Approx Weight	Approx 30.6 kg (67.5lbs)	
Terminal	T11	
Container Material	ABS	
Rated Capacity	104.0 AH/5.20A 100.0 AH/10.0A 88.0 AH/17.6A 76.2 AH/25.4A 63.8 AH/63.8A	(20hr , 1.80V/cell,25°C/77°F) (10hr, 1.80V/cell,25°C/77°F) (5hr, 1.75V/cell,25°C/77°F) (3hr, 1.75V/cell,25°C/77°F) (1hr, 1.60V/cell,25°C/77°F)
Max. Discharge Current	1200A (5s)	
Internal Resistance	Approx 4.9 m Ω	
Operating Temp.Range	Discharge Charge Storage	-15~50°C (5~122°F) 0~40°C (32~104°F) -15~40°C (5~104°F)
Nominal Operating Temp. Range	25 ± 3°C (77 ± 5°F)	
Cycle Use	Initial Charging Current less than 30.0A.Voltage 14.4V~15.0V at 25° C(77° F)Temp. Coefficient -30mV/°C	
Standby Use	No limit on Initial Charging Current Voltage 13.5V~13.8V at 25° C(77° F)Temp. Coefficient -20mV/°C	
Capacity affected by temperature	40° C (104° F) 25° C (77° F) 0° C (32° F)	103% 100% 86%
Self discharge	Batteries may be stored for up to 6 months at 25° C(77° F) and then a freshening charge is required. For higher temperatures the time interval will be shorter.	

Constant Current Discharge (Amperes) at 25 °C (77°F)

F.V/Time	10min	15min	20min	30min	45min	1h	2h	3h	4h	5h	6h	8h	10h	20h
1.85V/cell	146.4	123.2	107.7	77.5	61.5	49.9	31.0	24.2	19.6	15.9	13.9	11.3	9.4	5.31
1.80V/cell	187.1	148.9	127.3	91.4	71.6	55.9	33.9	26.0	20.9	17.1	14.9	12.0	10.0	5.36
1.75V/cell	205.6	162.6	136.9	94.9	74.3	58.5	35.1	26.5	21.4	17.5	15.3	12.2	10.1	5.41
1.70V/cell	224.1	173.6	143.9	98.8	77.2	60.4	36.5	27.2	22.0	18.0	15.6	12.4	10.2	5.51
1.65V/cell	241.8	184.6	152.8	104.2	79.2	62.4	37.5	28.4	22.7	18.5	16.0	12.6	10.4	5.58
1.60V/cell	262.5	197.4	162.8	110.0	82.5	64.6	38.8	29.3	23.4	19.1	16.3	12.7	10.5	5.61

Constant Current Discharge (watts/cell) at 25° C (77°F)

F.V/Time	10min	15min	20min	30min	45min	1h	2h	3h	4h	5h	6h	8h	10h	20h
1.85V/cell	273.2	232.3	205.2	148.8	119.0	96.9	60.4	47.2	38.4	31.3	27.4	22.4	18.7	10.6
1.80V/cell	344.4	276.5	238.8	173.5	137.3	107.9	65.6	50.6	40.8	33.5	29.3	23.7	19.8	10.7
1.75V/cell	373.8	299.1	254.8	179.3	141.8	112.5	67.8	51.4	41.6	34.3	30.1	24.1	20.0	10.8
1.70V/cell	401.7	316.9	266.3	185.8	147.0	115.7	70.3	52.7	42.6	35.1	30.7	24.5	20.2	11.0
1.65V/cell	430.4	334.8	281.5	195.2	150.2	119.2	72.1	54.8	44.0	36.0	31.3	24.8	20.6	11.1
1.60V/cell	459.4	353.8	296.8	204.0	155.1	122.5	74.1	56.2	45.1	37.0	31.9	25.0	20.8	11.2

Discharge Characteristics

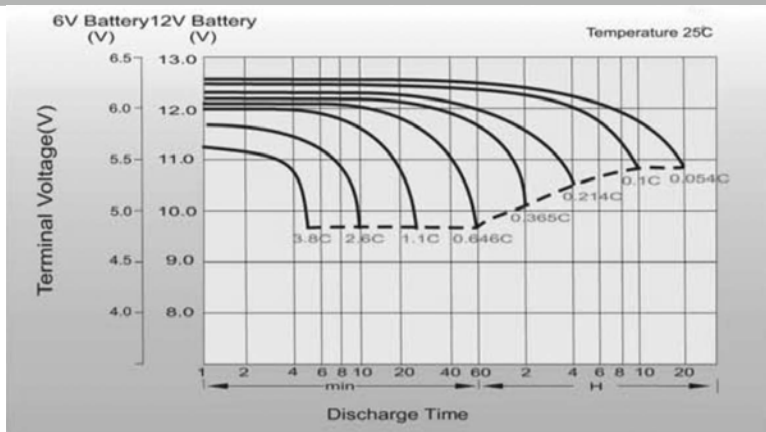

Charging Characteristics (cycle use)

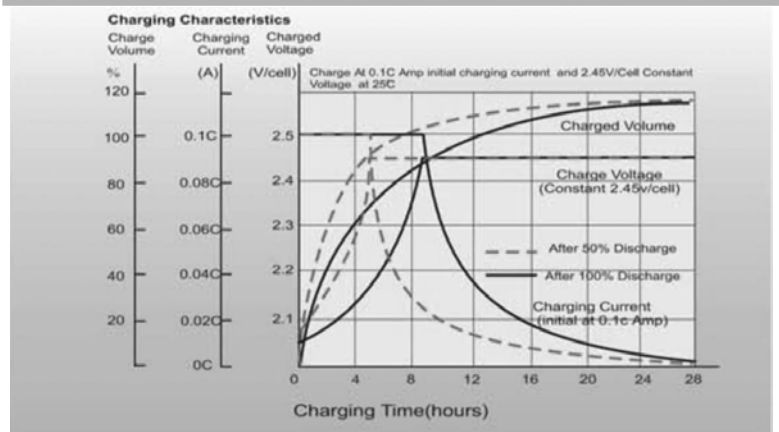

Temperature Effects in Relation to Battery Capacity

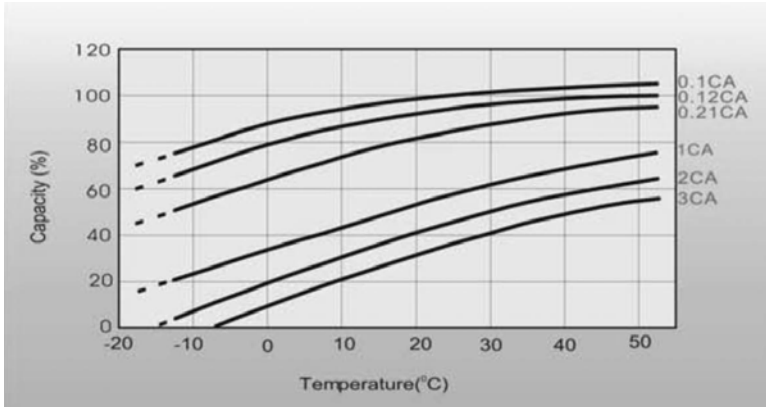

Cycle life in relation to depth of discharge

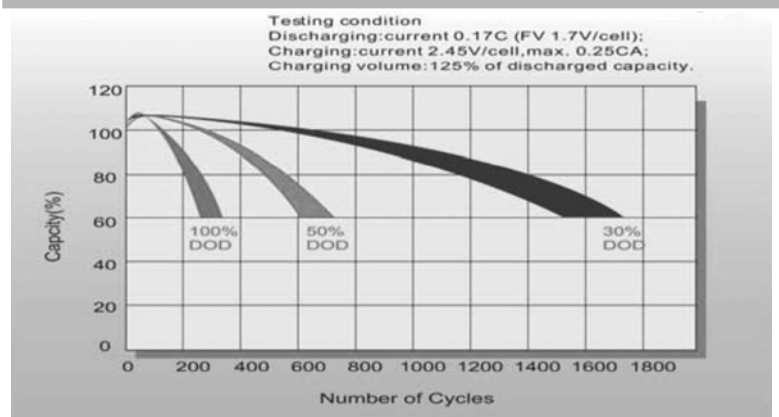

Self Discharge Characteristics

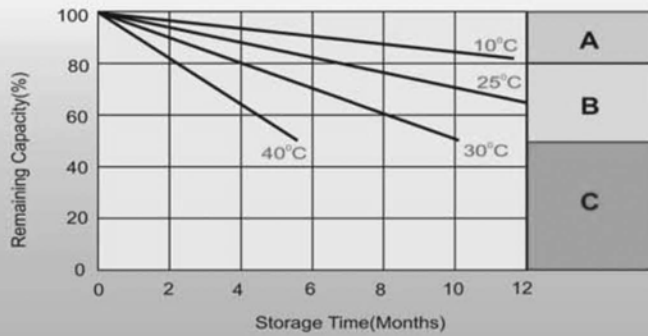

A No supplementary charge required
(Carry out supplementary charge before use if 100% capacity is required.)

B Supplementary charge required before use. Optional charging way as below:
1. Charged for above 3 days at limited current 0.25CA and constant voltage 2.25V/cell.
2. Charged for above 20 hours at limited current 0.25CA and constant voltage 2.45V/cell.
3. Charged for 8-10 hours at limited current 0.05CA.

C Supplementary charge may often fail to recover the capacity.
The battery should never be left standing till this is reached.

DIMENSIONS

T11 Terminal

Unit: mm [inches]

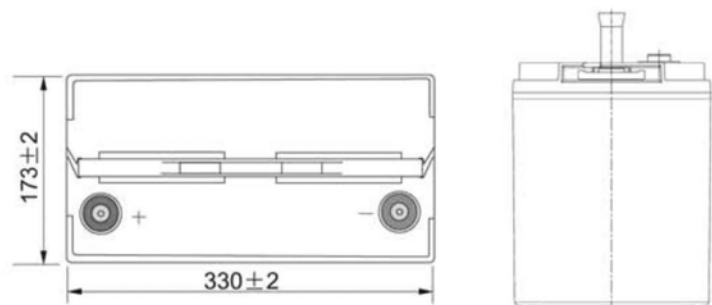
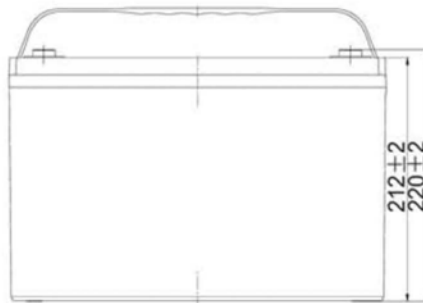
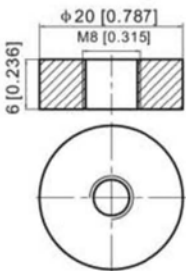

Hiltron Land S.r.l.

Strada Provinciale di Caserta, 218 80144 - Napoli - Italy
Tel: (+39) 081.185.39.000 Fax: (+39) 081.185.39.016
www.hiltronsecurity.net